

Software Product Lines with Unbounded Parametric Real-Time Constraints



TECHNISCHE
UNIVERSITÄT
DARMSTADT

FOSD Meeting (Grasellenbach, March 14, 2017)

Lars Luthmann

Andreas Stephan

Johannes Bürdek

Malte Lochau



Integrated Model-based Testing
of Continuously Evolving
Software Product Lines



ES Real-Time Systems Lab

Prof. Dr. rer. nat. Andy Schürr

Dept. of Electrical Engineering and Information Technology

Dept. of Computer Science (adjunct Professor)

www.es.tu-darmstadt.de

March 22, 2017

Running Example

[Alur et al. (1993): Parametric Real-time Reasoning]

Controller

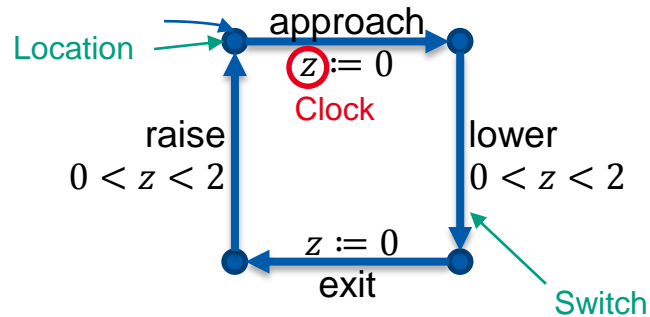

Gate

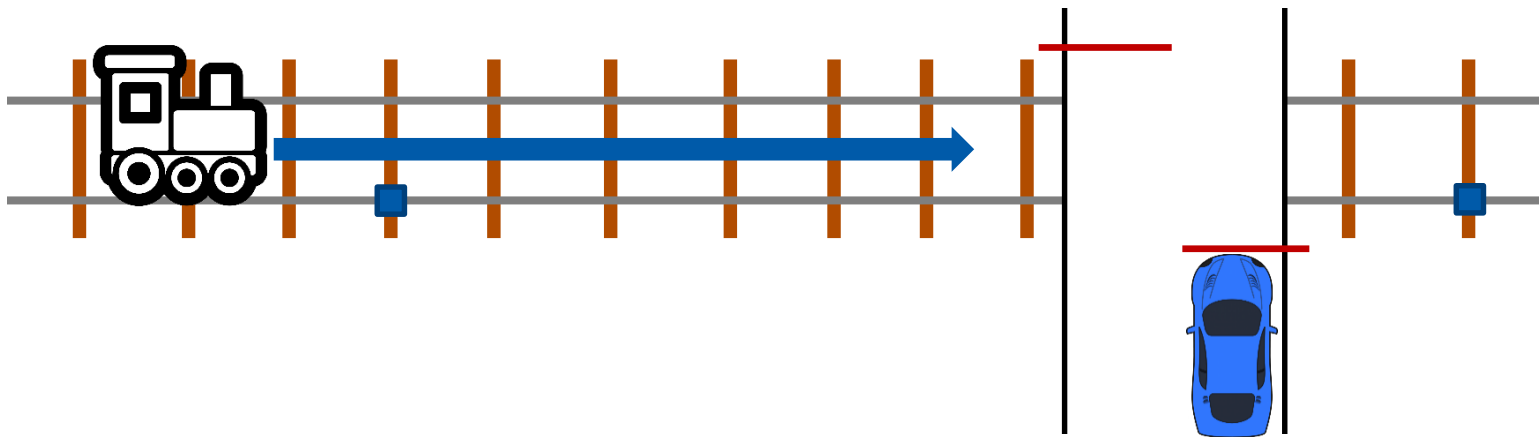
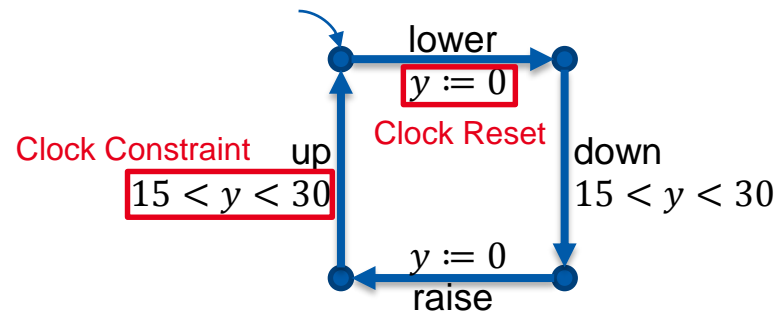

Product Line of TA

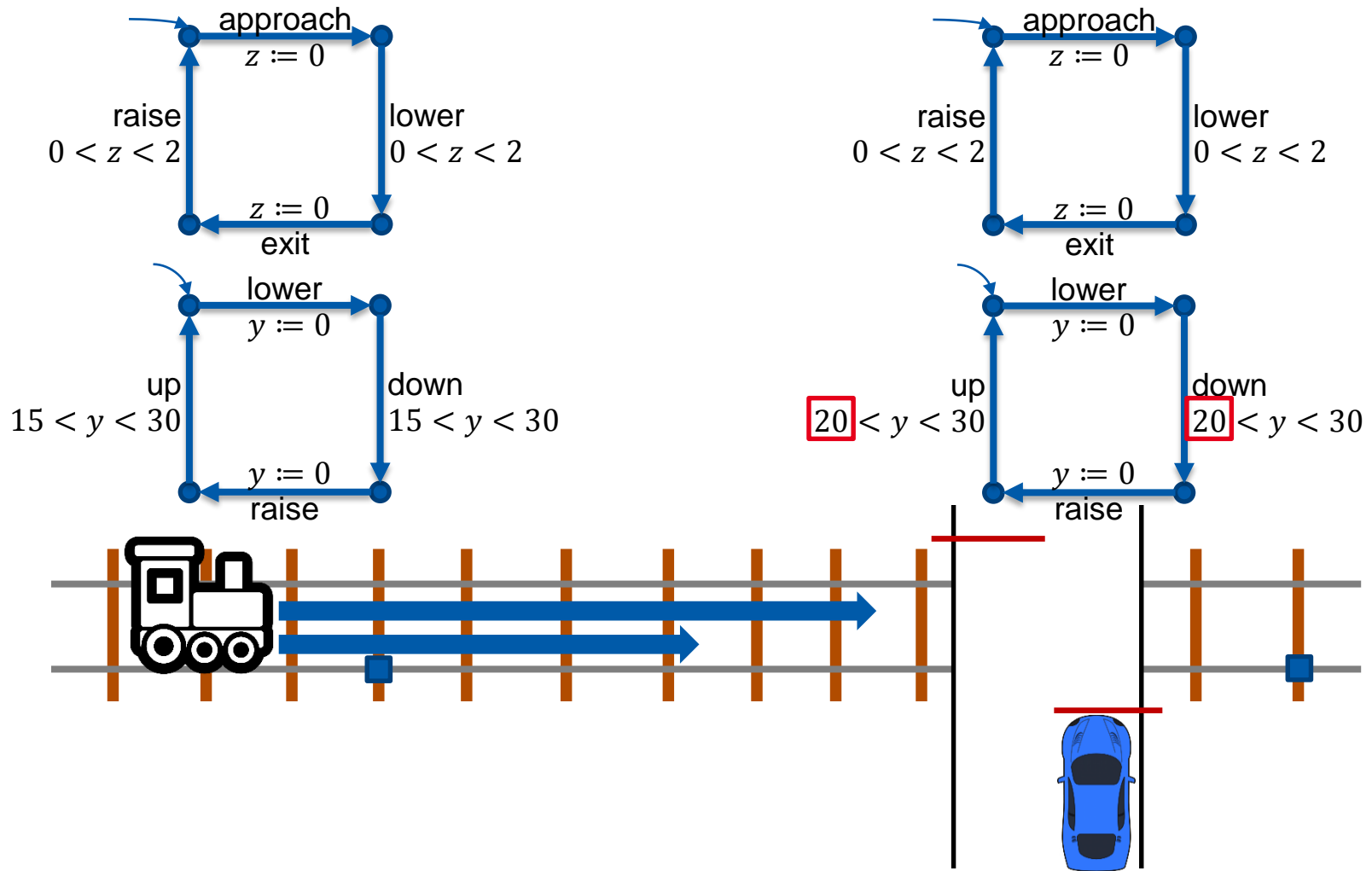

Featured Timed Automata (FTA)

[Cordy et al. (2012): Behavioural Modelling and Verification of Real-Time Software Product Lines]

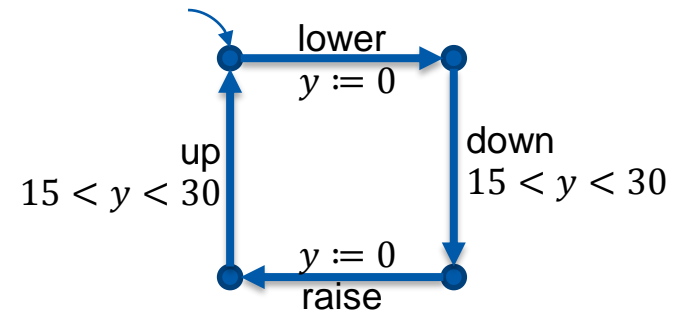
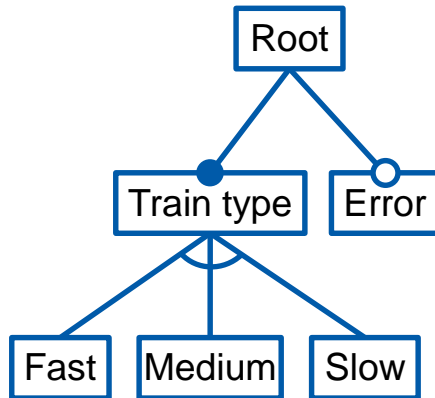

- Presence conditions for clock constraints and switches

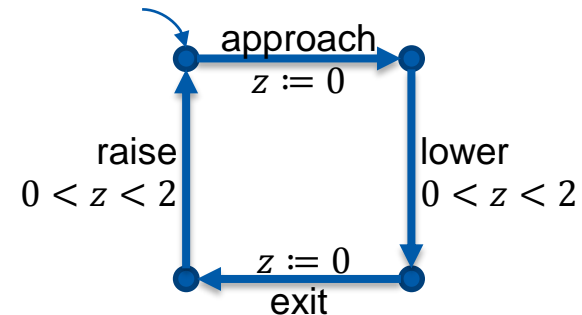

Featured Timed Automata (FTA)

[Cordy et al. (2012): Behavioural Modelling and Verification of Real-Time Software Product Lines]

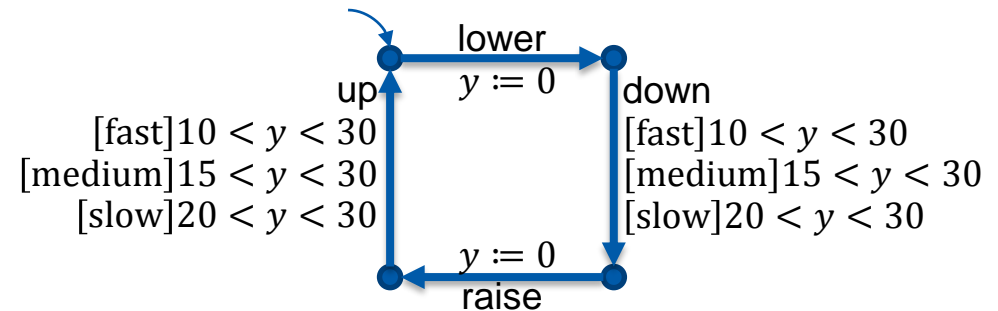
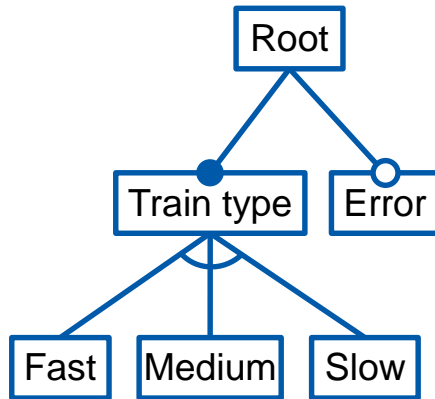

- Presence conditions for clock constraints and switches

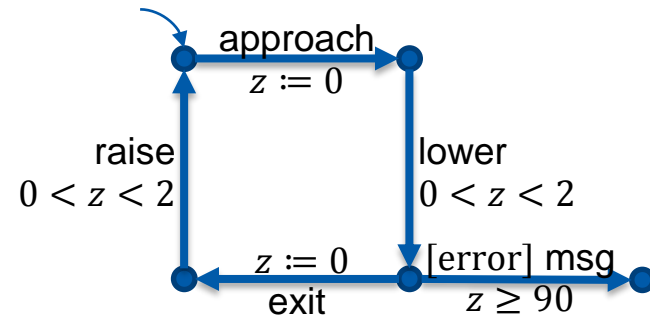

Parametric Timed Automata (PTA)

[Alur et al. (1993): Parametric Real-time Reasoning]

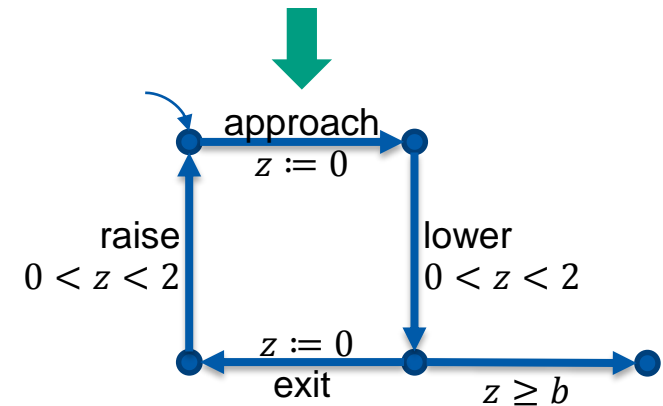
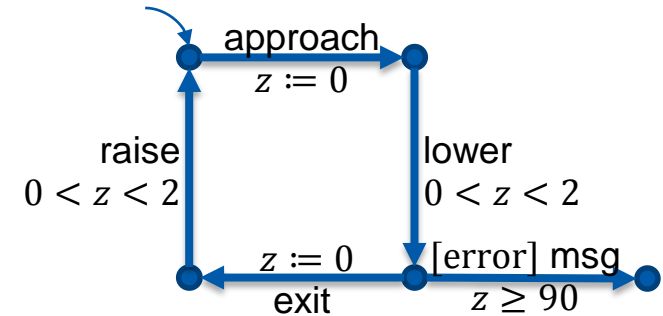
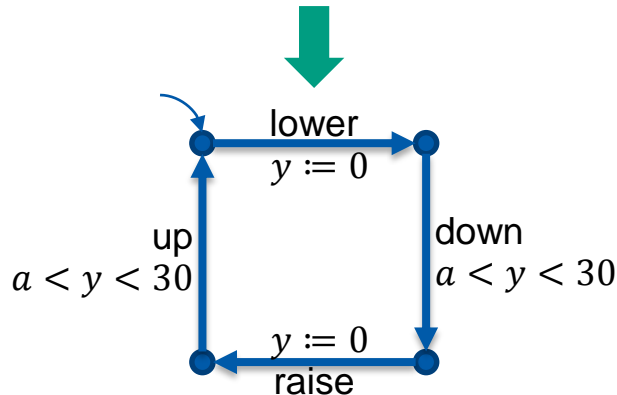
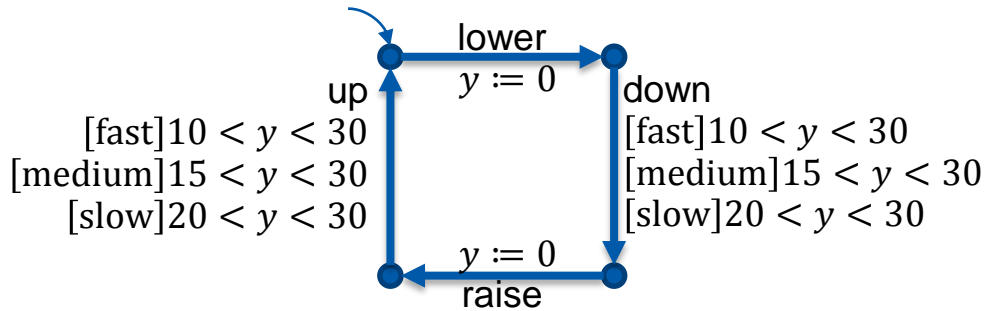

- Unbounded numeric parameters instead of Boolean features
- Results in (potentially) infinite number of configurations

Mutual encoding of FTA and PTA

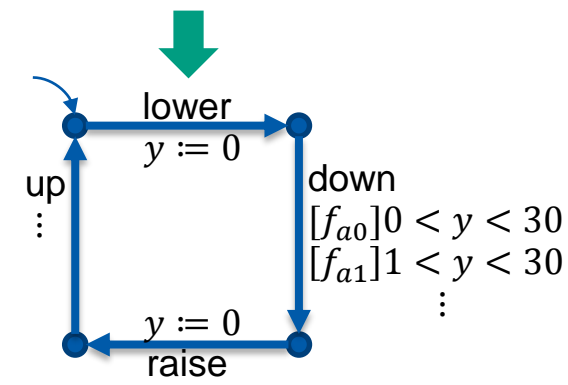
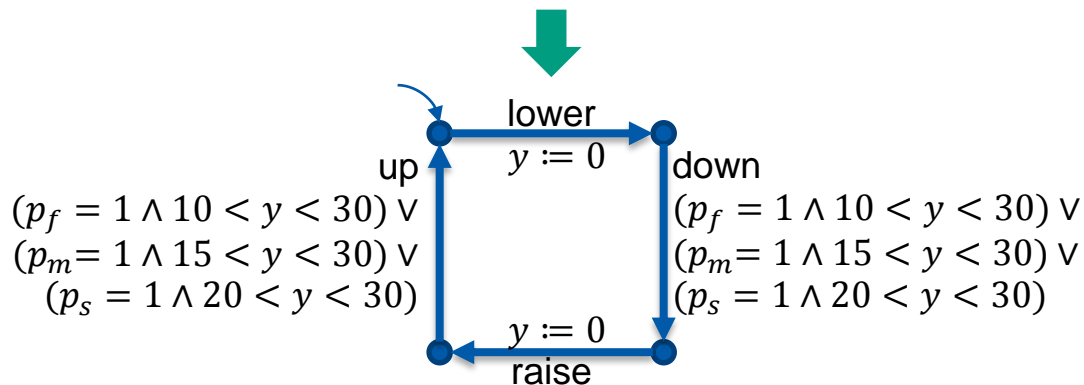
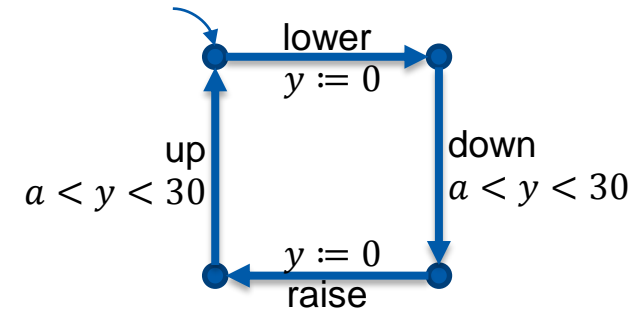
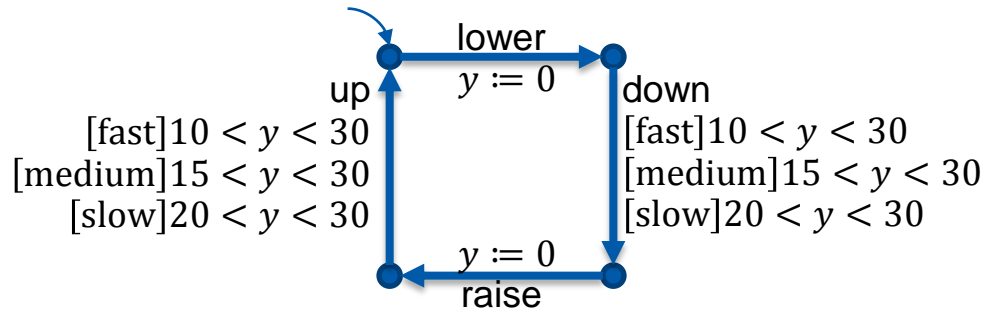

- FTA \rightarrow PTA: one parameter for each feature
- (Bounded) PTA \rightarrow FTA: one feature for each parameter valuation
- Restriction: Unbounded parameter domains cannot be mapped



Unbounded Real-Time Constraints

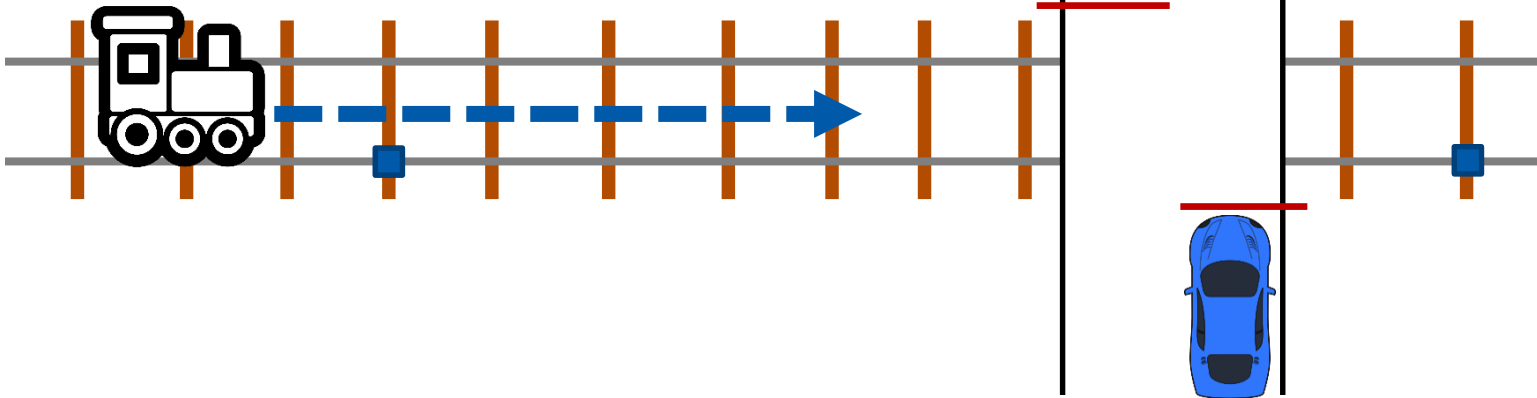
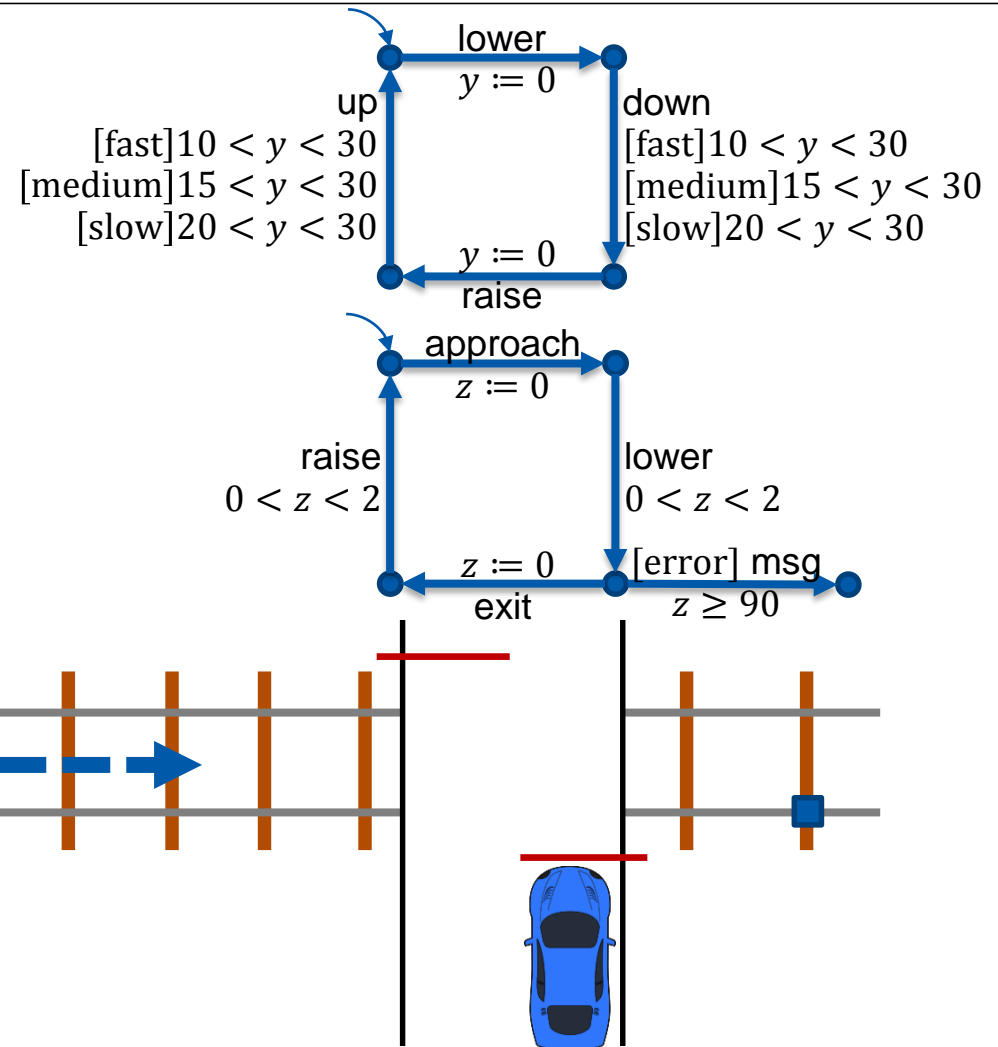
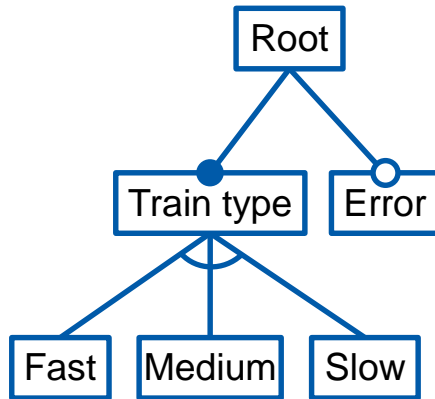

Unbounded Real-Time Constraints

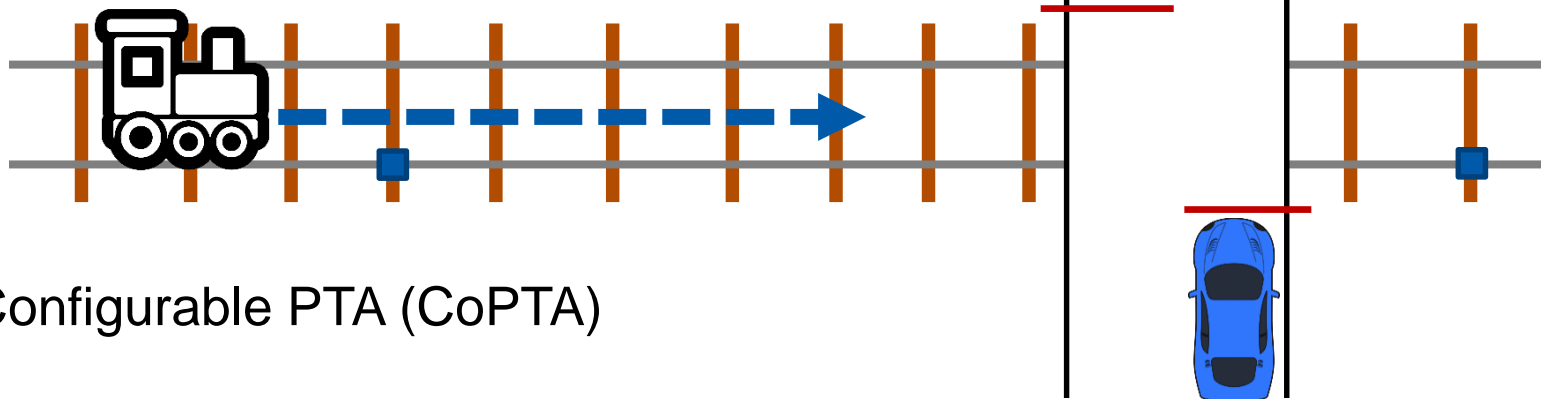
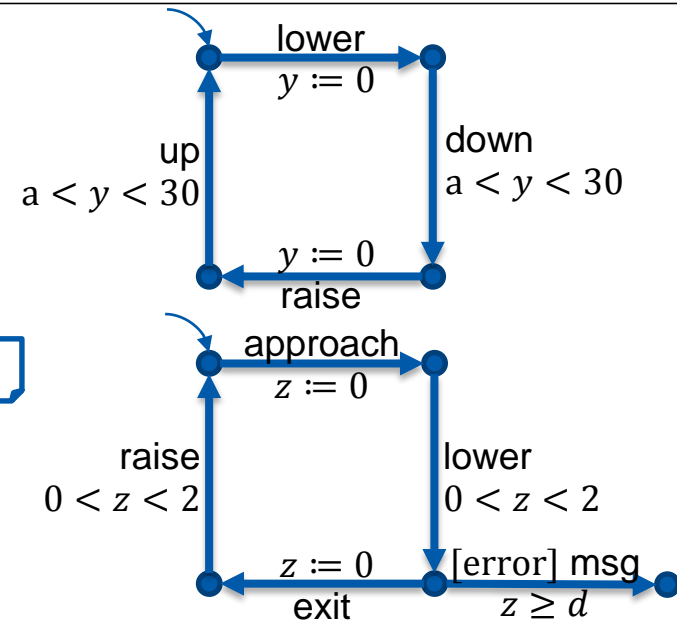
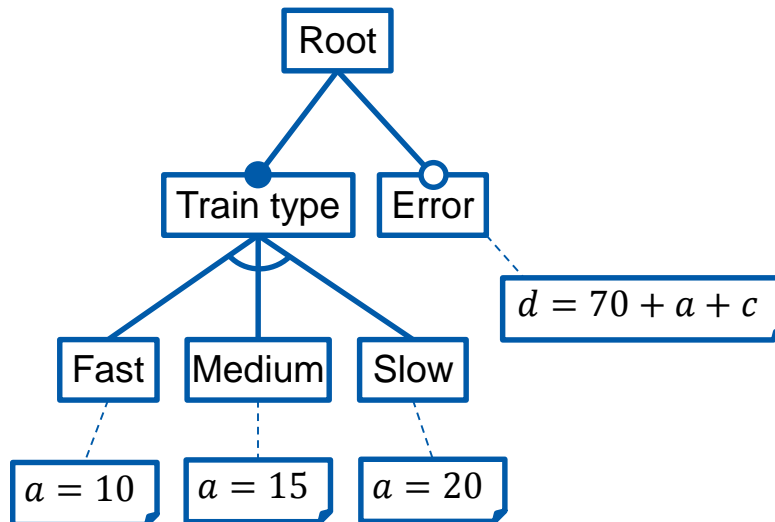

⇒ Configurable PTA (CoPTA)



Test-Case Generation

[Bürdek et al. (2015): Facilitating Reuse in Multi-goal Test-Suite Generation for Software Product Lines]
 [André (2009): IMITATOR: A Tool for Synthesizing Constraints on Timing Bounds of Timed Automata]

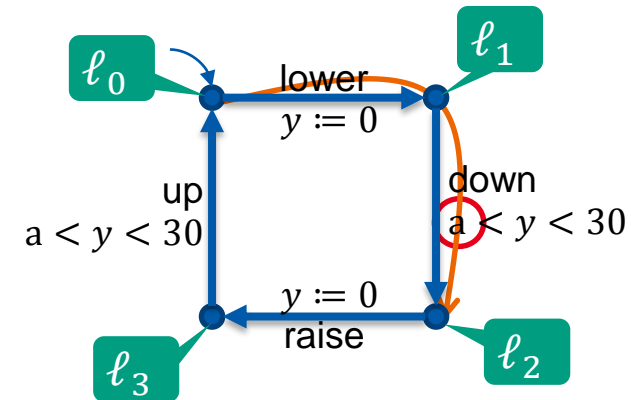
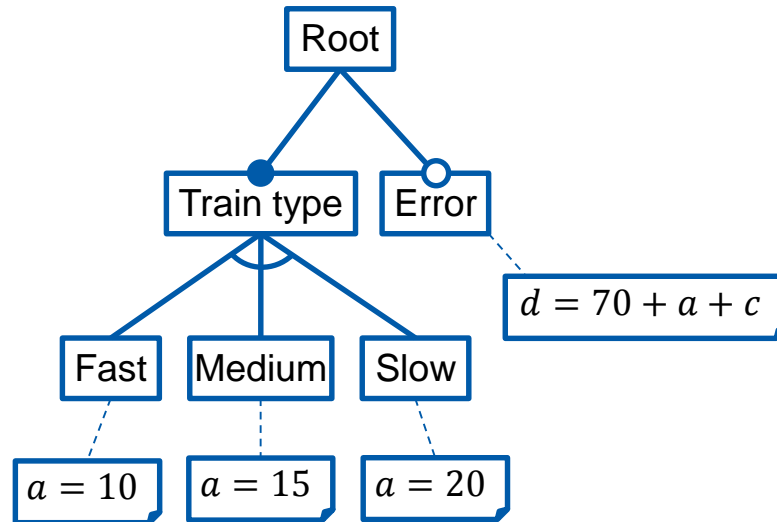

- Test case for l_2 : $l_0 \xrightarrow{(7,lower)} l_1 \xrightarrow{(12,down)} l_2$
- May be reused for l_1 [Bürdek et al., 2015]
- May be reused for configurations with feature *fast* [Bürdek et al., 2015]
- Implementation based on Imitator [André, 2009]

Test-Case Generation

[Bürdek et al. (2015): Facilitating Reuse in Multi-goal Test-Suite Generation for Software Product Lines]
[André (2009): IMITATOR: A Tool for Synthesizing Constraints on Timing Bounds of Timed Automata]

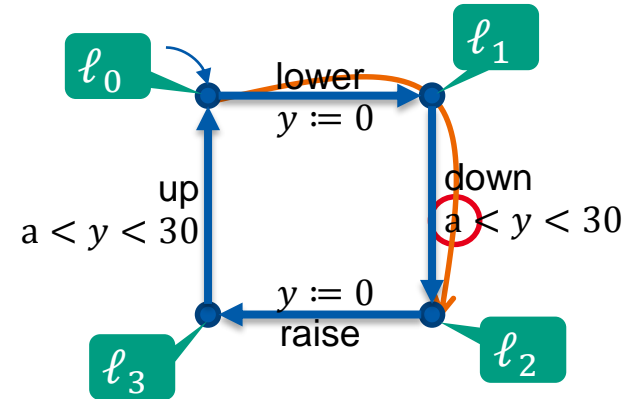
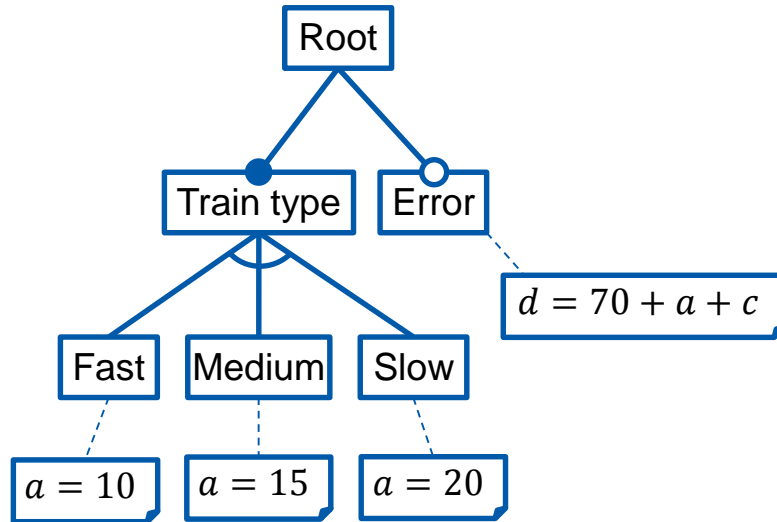

HelicPTA

Evaluation (Gear Control)

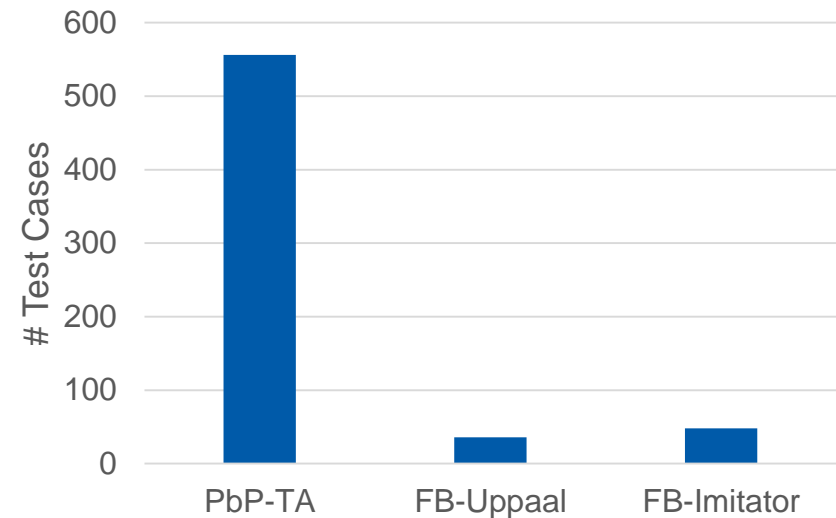
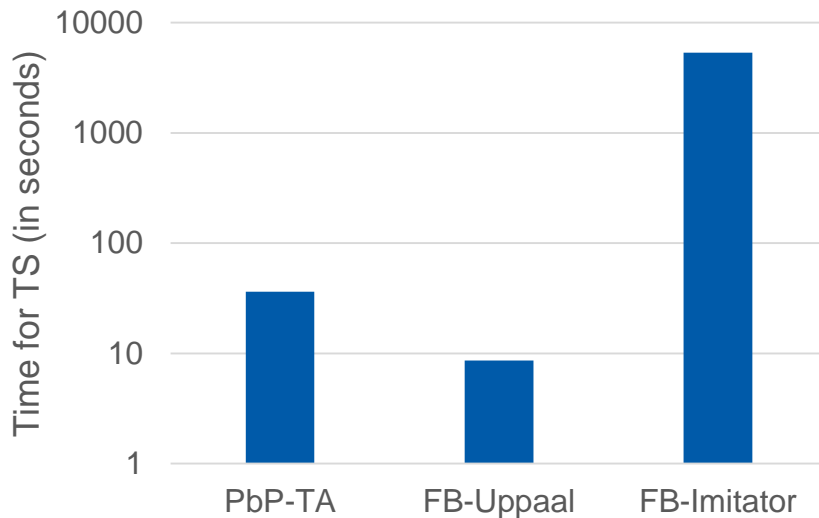

- Can we reduce computational effort and the test suite size?
- 66 locations
- 22 Variants
- No unbounded parametric variability

Conclusion

- Family-based approach with FTA:
 - Smaller test suite
 - Faster test-suite generation
- Family-based parametric approach with CoPTA:
 - Slower test-suite generation
 - Potentially unlimited amount of variants
- Generate CoPTA models from source code



[https://commons.wikimedia.org/wiki/File:Future_plate_blue.svg]

Decidability Properties for PTA

[André (2008): What's decidable about parametric timed automata?]

- \mathcal{P} -emptiness: Is a property satisfiable with a given parameter valuation?
- \mathcal{P} -universality: Is a property satisfiable for all parameter valuations?
- \mathcal{P} -finiteness: Is the set which satisfies a given property finite?

Decidability Results for PTA

[André (2008): What's decidable about parametric timed automata?]

Time Domain	Parameter Domain	P-Clocks	NP-Clocks	Params	Decidable?
\mathbb{N}_0	\mathbb{N}_0	3	0	1	No
\mathbb{R}_+	\mathbb{N}_0	2	any	1	Yes
\mathbb{R}_+	\mathbb{N}_0	3	0	1	No
\mathbb{R}_+	\mathbb{N}_0 (bounded)	any	any	any	Yes
\mathbb{R}_+	\mathbb{Q}_+	1	0	any	Yes
\mathbb{R}_+	\mathbb{R}_+	1	3	1	No

Evaluation (Train-Gate-Controller)

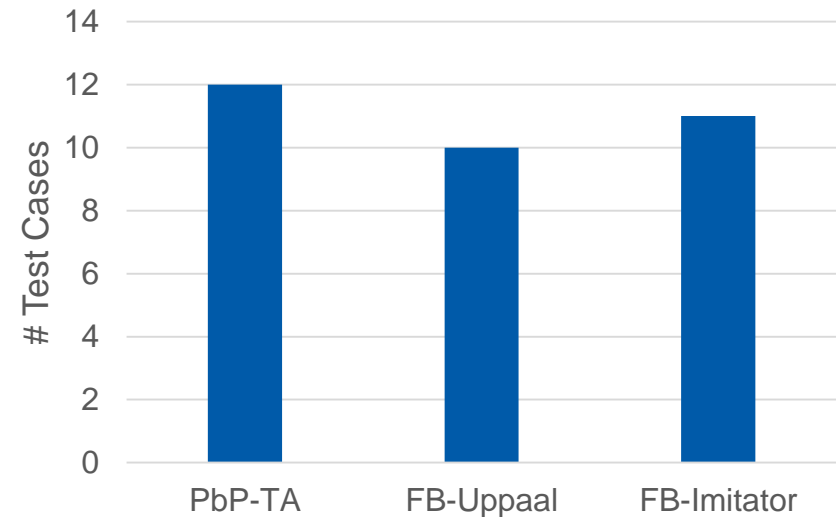
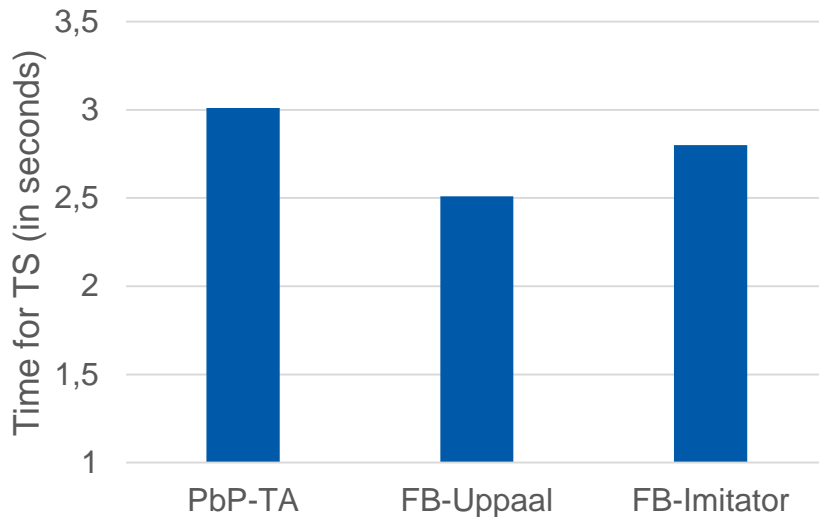

- 12 locations
- 2 Variants
- No unbounded parametric variability